

BRIGHTWELL



MULTIPLEX ON BOARD SCREEN CONFIGURATION

INDUSTRIAL LAUNDRY DOSING SYSTEM

INSTALLATION - SETUP



CONTENTS

LOGGING INTO YOUR SYSTEM AS AN ADMINISTRATOR	4
SETTING UP A CHANNEL ON YOUR UNIT	6
SETTING UP A PRODUCT ON YOUR UNIT	12
SETTING UP A WASHER ON YOUR UNIT	17
SETTING UP A FORMULA ON YOUR UNIT	24
COPYING AN EXISTING FORMULA	28
WASHER EXTRACTOR STATUS	30
CHANNEL STATUS	32
LATEST DOSAGES	33
PRODUCTION STATISTICS AND ALARMS	34
RUNNING A CALIBRATION ON YOUR UNIT	35
CHANGING THE LANGUAGE ON YOUR UNIT	38
CHANGE THE UNIT OF MEASUREMENTS	39
CHANGING DOSAGE VOLUME UNITS	40

OVERVIEW



- 1 Main Menu for the Multiplex unit. Displaying buttons for the following menus;
 - **W.E Status** - Stands for Washers. Allowing you to view the real time information of the attached machines.
 - **Channel Status** - Shows a setup diagram of your Multiplex system with real time view functionality.
 - **Last Dosages** - Quickly view the completed chemical doses on this machine.
 - **Statistics and Alarms** - Here you can view the dosage and alarm log for your unit.
- 2 These arrows will appear on each side of the screen to indicate you can expand the menus out. This will display icons 3-6 described below.
- 3 Configuration Menu - From here you can access the following options (**Please note - You will need to log in as an administrator to access**)
 - **Channels** - Where you can set up and edit the settings for each channel in your Multiplex setup.
 - **Products** - Create and edit the product settings on your system.
 - **Washers** - Create and edit washer settings for your Multiplex.
- 4 Formula's menu - This menu allows you to access the setup and configuration screens for your unit's formulas;
 - Edit Formulas
 - Copy Formulas
 - Dose G/Kg - Change the measurement metric for dosing
- 5 Administration menu - From here you can change settings of the unit and log in as an administrator;
 - **Language** - Adjust the current language for your display.
 - **Unit of measurement** - Switch between metric and imperial units of measurements.
 - **Log in** - Log into your Multiplex as an administrator to adjust settings.
- 6 Calibration menu - Here you can run a calibration on your Multiplex unit.

LOGGING INTO YOUR SYSTEM AS AN ADMINISTRATOR

STEP 1

To adjust settings on your Multiplex system you will need to log into it as an administrator. To do this tap the right side of the screen to get the icons to appear.

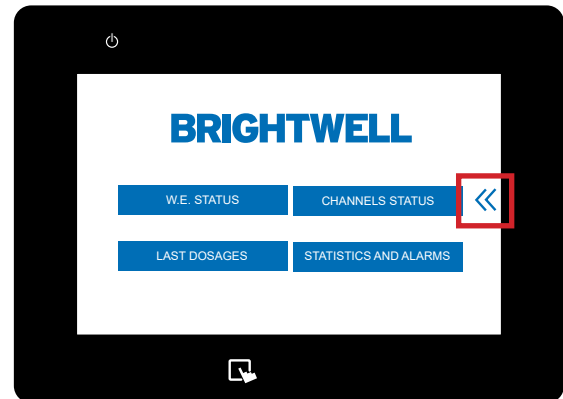

STEP 2

Tap on the **Administration Menu** icon in the top right of the screen.

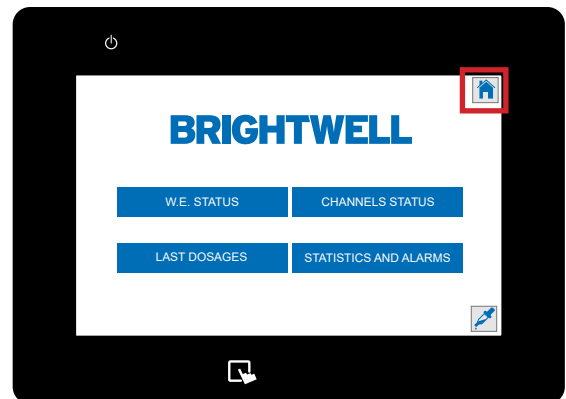

STEP 3

The **Administration Menu** will now open and you can access the Log in function pressing the "Log in" button.



STEP 4

A pop up will appear allowing you to enter your user name and password details for the unit. Enter these to log in as an administrator.

(This was setup during the order process. Please contact your administrator to confirm details)



LOGGING INTO YOUR SYSTEM AS AN ADMINISTRATOR

STEP 5

If this has been successful you will receive confirmation. You can now access the administrator functions for this unit.



SETTING UP A CHANNEL ON YOUR UNIT

STEP 1

Once you have logged into your Multiplex system you can setup and edit the channels via the **Channels menu**. To locate this tap the left hand side of the screen to show the **Configuration Menu** icon.

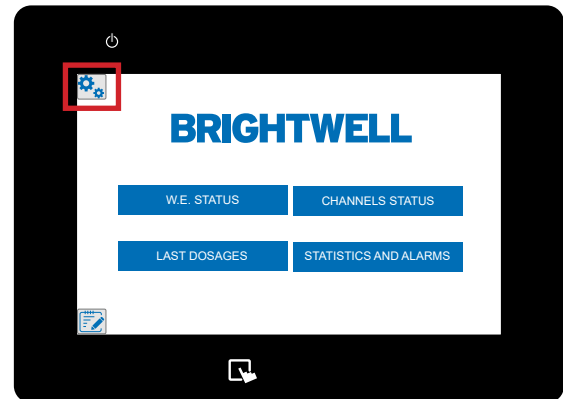

STEP 2

Once this menu has expanded press the **Channels** button located at the top.

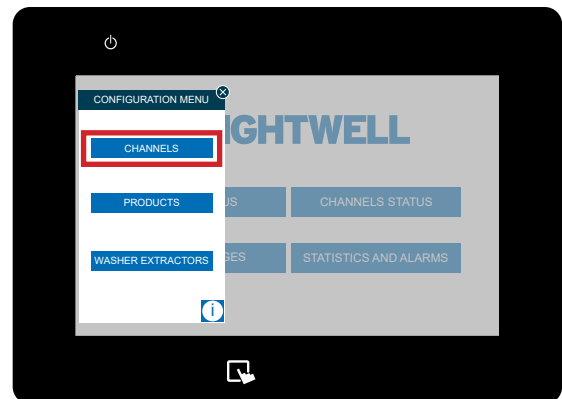

STEP 3

The channel screen will now be displayed. Select the channel you want to edit by pressing the box at the top. If no channels exist press the **+** icon in the top right.

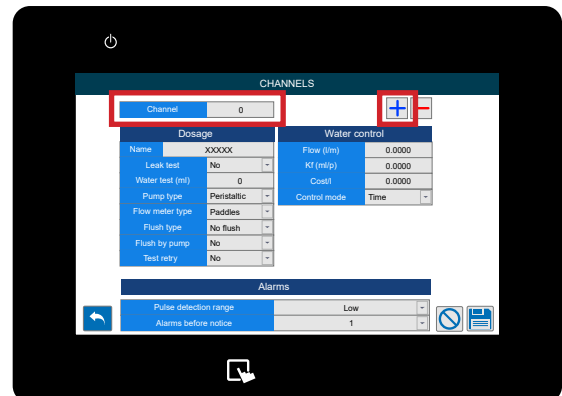

STEP 4

Once you have selected the correct channel number you can adjust the name using the text box provided.

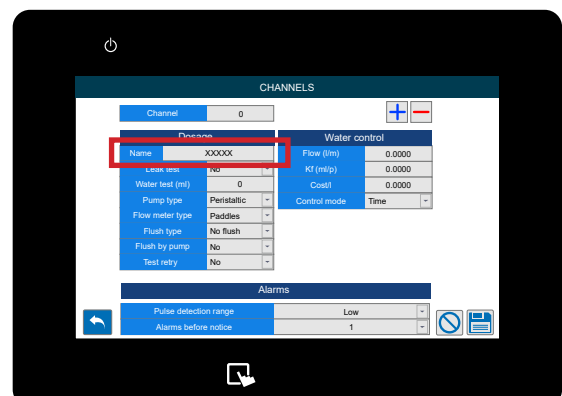

SETTING UP A CHANNEL ON YOUR UNIT

STEP 5

Next enable or disable the **Leak Test** for the channel.

A leak test ensures that none of the valves on the unit are damaged by closing the valves and driving water to them, looking at the flow meter to see if any Pulses are detected. It is highly recommended that this option is enabled, however it may be needed to be deactivated for some examples;

- The pipe is soft and allows for expansion or compression
- There is a longer distance of pipe to the distributor
- The channel product is dosed directly to the distributor

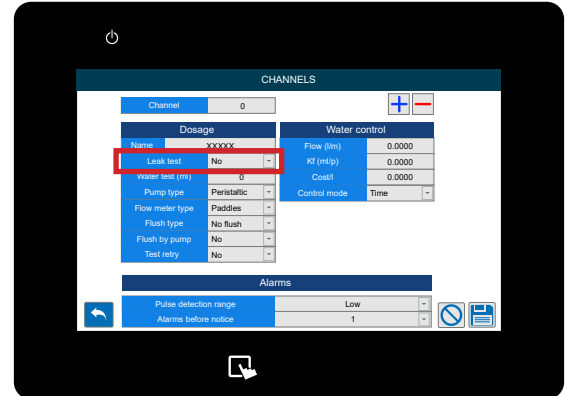

STEP 6

Next you can adjust the water test volume for your channel. The minimum value for this is 700 ml to ensure a correct test and separation of chemicals.

A water test is used to verify that the minimum indispensable conditions and that the product will reach its destination. A water test is recommended when products with high viscosity or high surface tension pass through the channel.

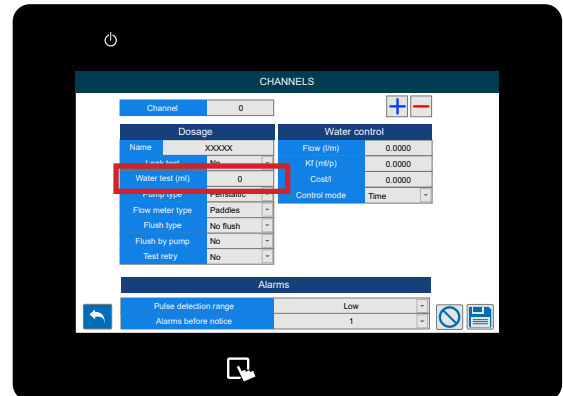

STEP 7

If you need to adjust the pump type for the unit you can use the drop down menu to choose between;

- Peristaltic
- Motor
- Membrane
- Pneumatic
- Venturi

The recommended configuration for the Multiplex is water or air flush with a membrane or pneumatic pump. (Based on each site).

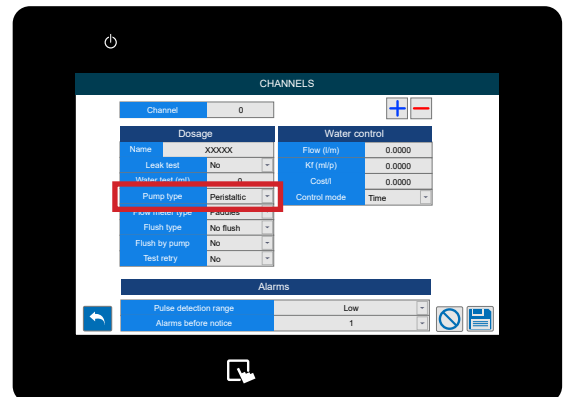

STEP 8

Select the correct Flow Meter Type using the drop down;

- Paddles
- Oval-Gear
- Thermal

Please note: Do not change this unless you have replaced the flow meter provided from your supplier.

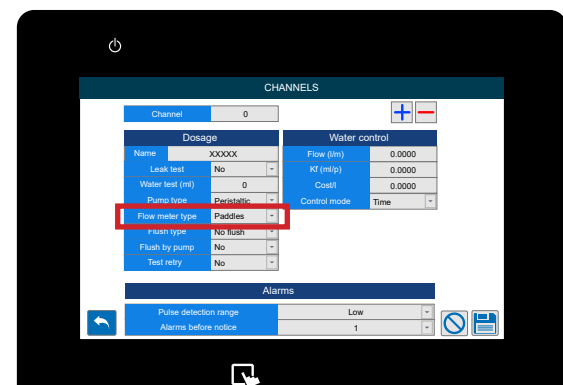

SETTING UP A CHANNEL ON YOUR UNIT

STEP 9

If you need to adjust the Flush Type for the channel use this drop down to choose between;

- No Flush
- Only Water
- Air

It is recommended to use water for set-ups where the distance between the distributor and unit is under 40 metres. Over 40 metres we advise using Air flush and a water test of over 700ml to prevent product residue building up.

It is only recommended to use no flush when you have chemicals that become more viscous with water or the product is going directly to the washer.

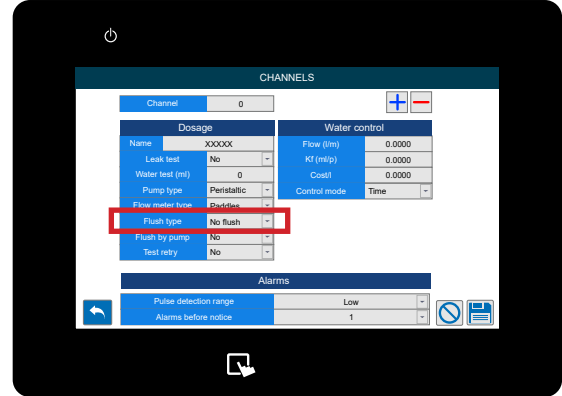

STEP 10

Another flush setting can be adjusted next, selecting if you are flushing with only a pump or not.

***This is not a recommended setup option and is only used when you do not have pressure regulated water for your setup. If this is the case, we advise the purchase of a booster tank to stabilise water pressure and ensure unit performance and reliability.**

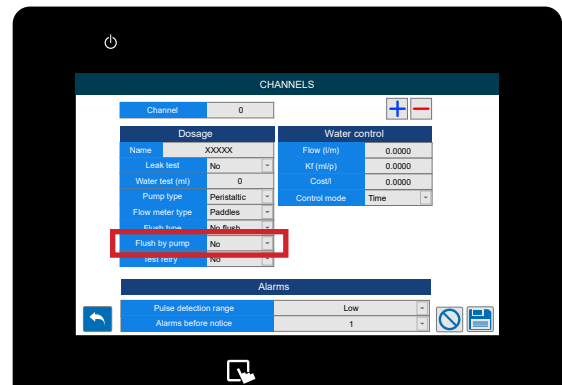

STEP 11

If you want to setup a **Retry the Water Test** on this channel press the drop down to toggle between **Yes** or **No**.

During operation there may be an unforeseen event where the correct level of water is not delivered between products. Enabling this feature will allow a second test on this to accommodate this potential issue.

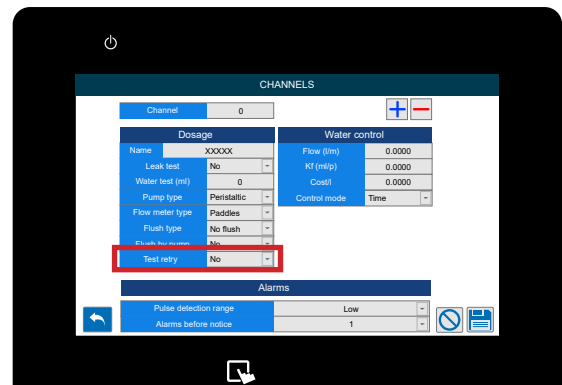

STEP 12

Under the Water Control column you can see the Flow Rate for the unit.

(Please note - These values are generated automatically by running a calibration on the unit. Covered here - [Running a Calibration \(P35\)](#))

***We DO NOT advise setting the values manually**

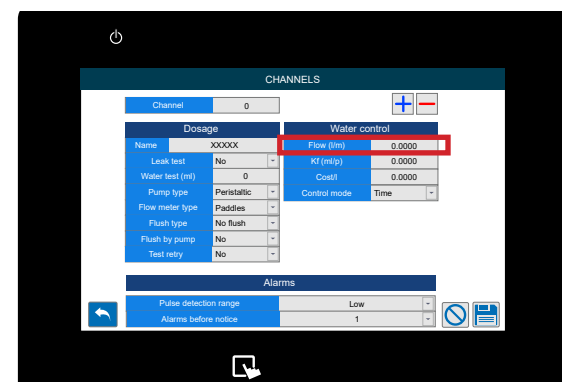

SETTING UP A CHANNEL ON YOUR UNIT

STEP 13

Below this you can adjust the Kf flow.

(Please note - These values are generated automatically by running a calibration on the unit. Covered here - [Running a Calibration \(P35\)](#))

*We **DO NOT** advise setting the values manually

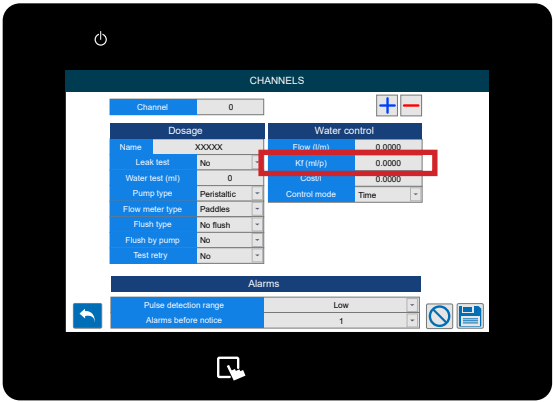

STEP 14

Next is the **Cost** value for the water of this channel, this is used for cost reporting.



STEP 15

The final setting in this menu is the **Control Mode**. Where you can select between Time or Flow meter.

*We recommend using a flow meter for your Multiplex as it guarantees accurate chemical delivery to your machines. This option is to allow for temporary use of the unit while you await repairs.

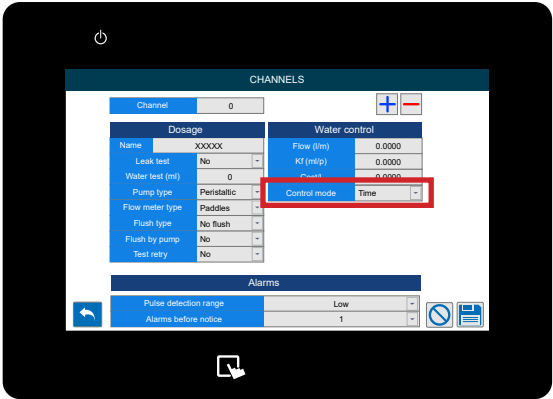

STEP 16

At the bottom of the screen you can see the **Alarms** settings. The first box allows you to setup the **Pulse Detection Range**. You can select between;

- Low (30%)
- Medium (50%)
- High (70%)
- Maximum (100%)

This is the additional time that can be added for the flow meter to detect the correct volume of chemical. A more detailed explanation is on the next page.

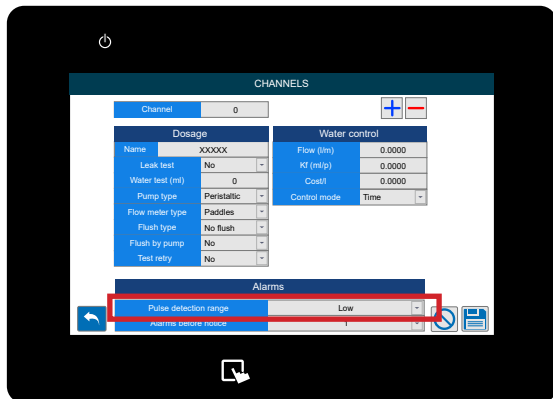

SETTING UP A CHANNEL ON YOUR UNIT

PULSE DETECTION RANGE

When dosing chemical it may be required to increase the detection range to allow for fluctuations in flow for the product. This may be needed when there is potentially gassing products causing gas to expand in the pipe, or very viscous products that can become more difficult to pump if left sedentary.

Below is a graph explaining the functionality.

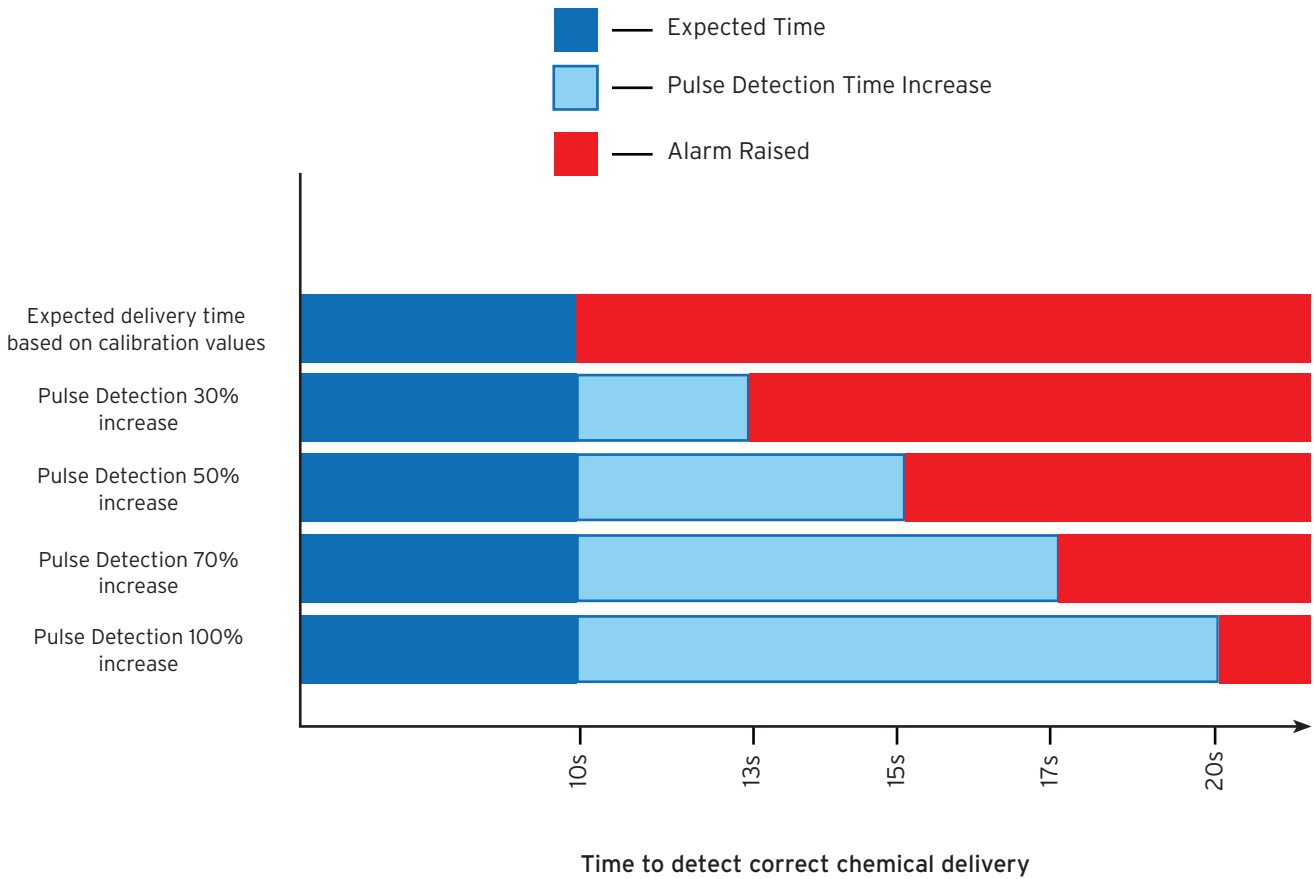

Please note - we advise setting this to as close to the expected delivery time as possible for accurate results and early warning of any potential hardware failures that may arise. Setting this to the maximum level by default will potentially hide maintenance issues that could be resolved before failure of the part.

SETTING UP A CHANNEL ON YOUR UNIT

STEP 17

Below this you can set the number of retries before an alarm is raised.

The feature is only available with a flow meter installed. This stops consecutive audio alarms from sounding on the unit to reduce noise pollution in the laundry.

This is ONLY for the product dosage and water flush test. Not initial leak test.

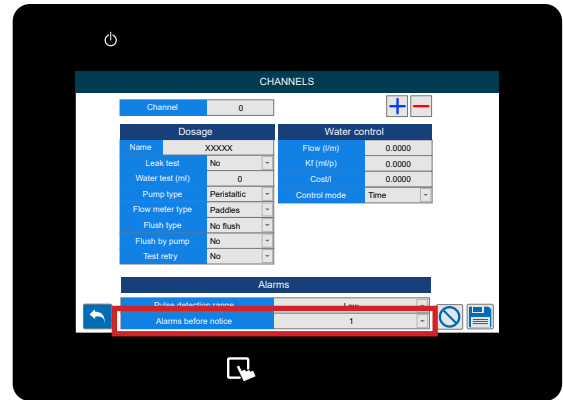

STEP 18

The icons at the bottom of the screen allow you to;

- Go back
- Delete the channel (- Top right)
- Clear changes made
- Save the settings

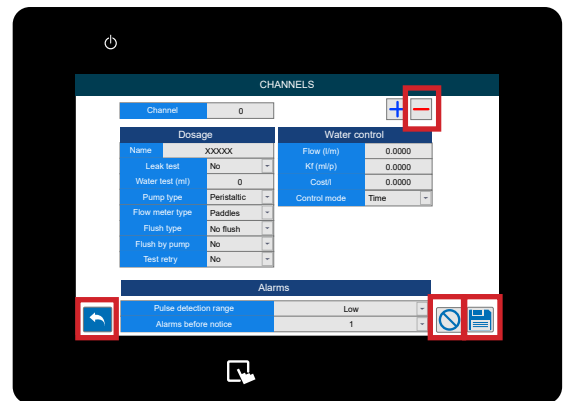

SETTING UP A PRODUCT ON YOUR UNIT

STEP 1

Once you have logged into your Multiplex system you can setup and edit the products via the **Products menu**. To locate this tap the left hand side of the screen to show the **Configuration Menu** icon.

Please note - This is only available through the on board screen. If you are using the web server or portal these products are defined in the Catalogue pages there.

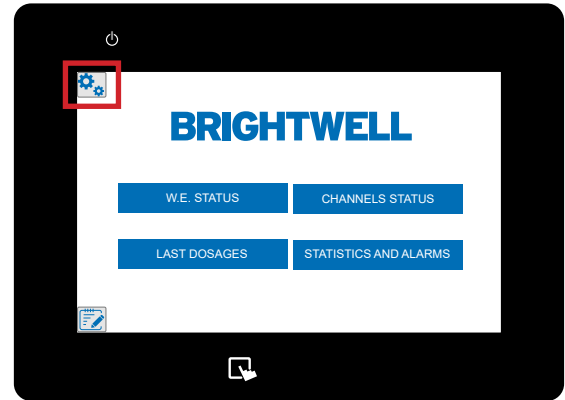

STEP 2

Once this menu has expanded press the **Products** button located in the middle.



STEP 3

The products screen will now be displayed. Select the channel that the product is linked to using the selector at the top.

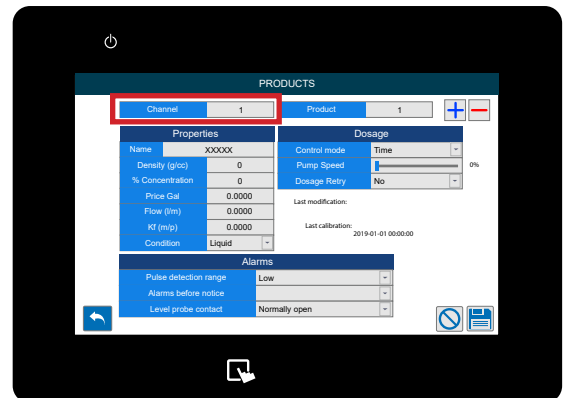

STEP 4

You can now change the **Product Number** using the selector to the right of the channel.

Please note - If you do not have any existing chemicals you will need to press the + icon on the right to create a new one.

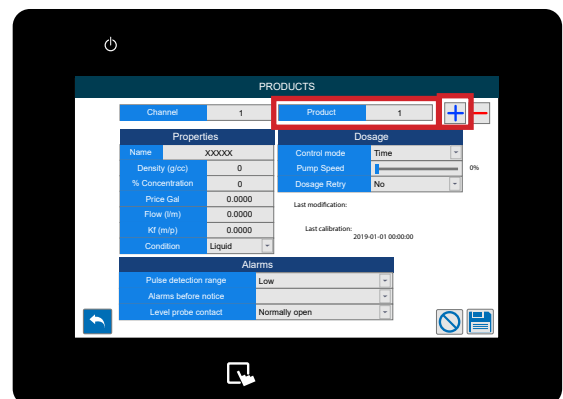

SETTING UP A PRODUCT ON YOUR UNIT

STEP 5

Under the properties tab you can select the **Product Name** value and set a custom name.

It is advisable to be very precise with the name so no errors are made in selection.

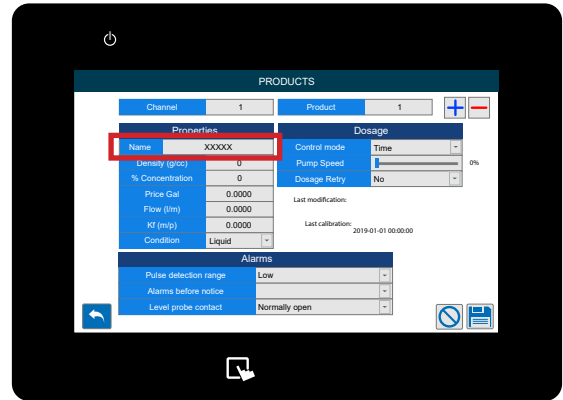

STEP 6

The next box allows you to set the **Density** of the product. Please refer to the chemical manufacturers values for this.

We recommend that this value is precise and based on the chemical datasheet. As this directly effects the dosage of the chemical
X value density / 1kg of laundry

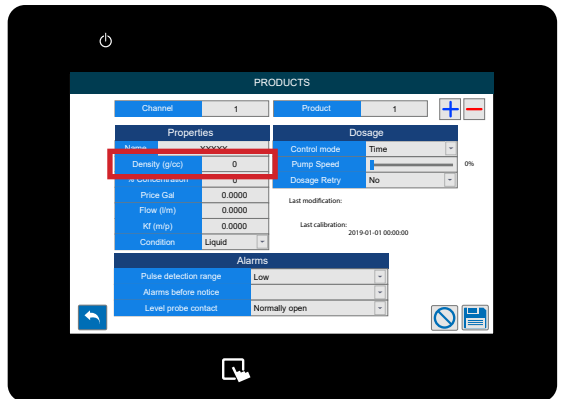

STEP 7

Next set your **Product Concentration** percentage if this is diluted.

If you are using products in pre-dilution and want the 'grams of pure product' you should set this field percentage to the direct dilution of the product. For example;
1000 litres you use 100kg of product your % = 1000/100 = 10%
**Changing this value will effect all formulas.*

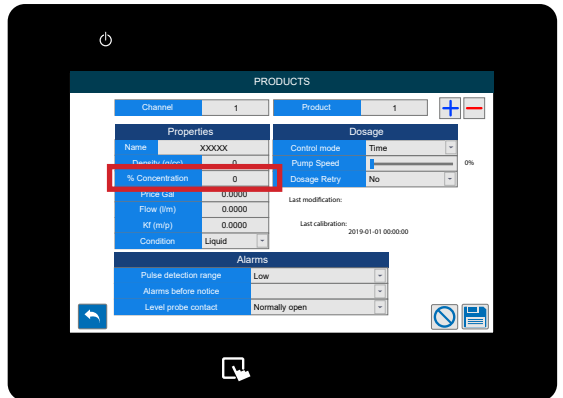

STEP 8

Below you can set the **Price per KG** of the product for cost reporting.

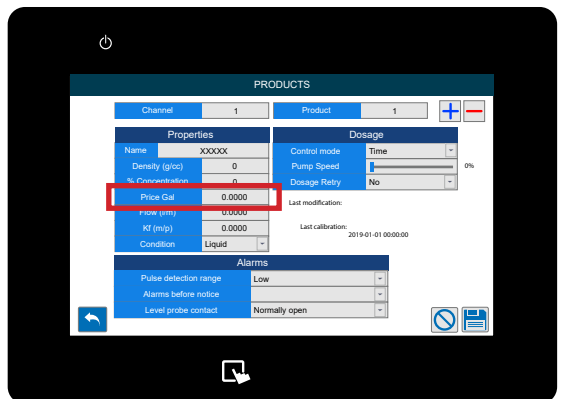

SETTING UP A PRODUCT ON YOUR UNIT

STEP 9

You can now set up the **Flow Rate** value for the chemical here.

(Please note - These values are generated automatically by running a calibration on the unit. Covered here - Running a Calibration (P35)

*We DO NOT advise setting the values manually

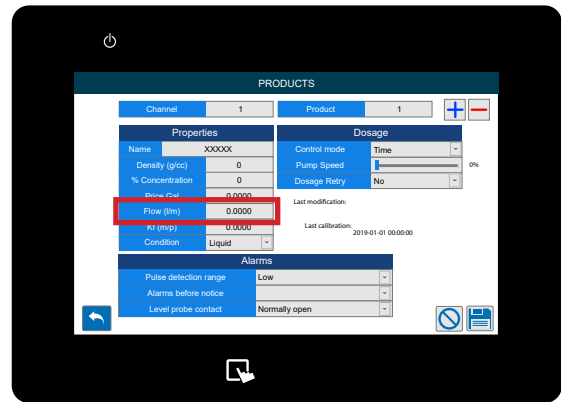

STEP 10

If your product has a **Kf** value please use the highlighted box to set as required.

(Please note - These values are generated automatically by running a calibration on the unit. Covered here - Running a Calibration (P35)

*We DO NOT advise setting the values manually

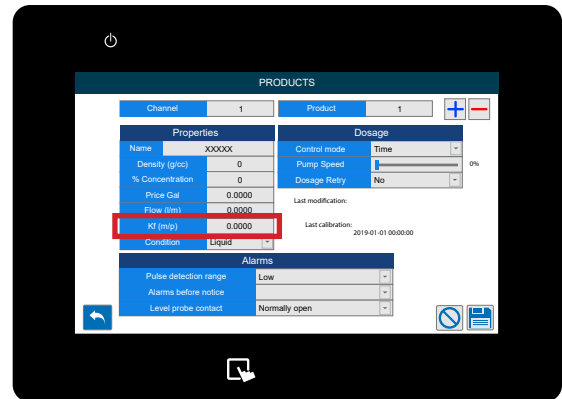

STEP 11

You can now adjust the **State** of the product using the drop down. You can select between;

- Liquid
- Solid Solution

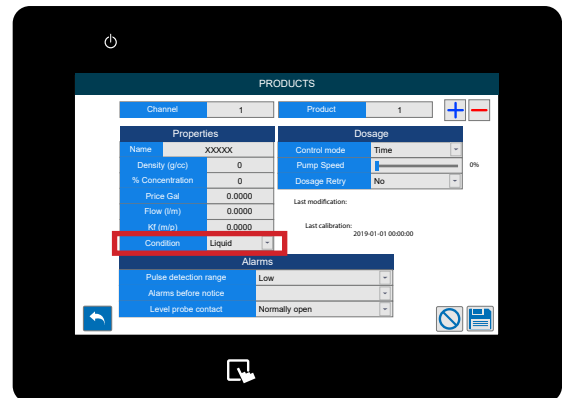

STEP 12

Under the Dosage menu you can choose between the **Control Modes**;

- Time
- Flow Meter

We recommend using a flow meter for all setups to maximise the full functionality of your multiplex unit.

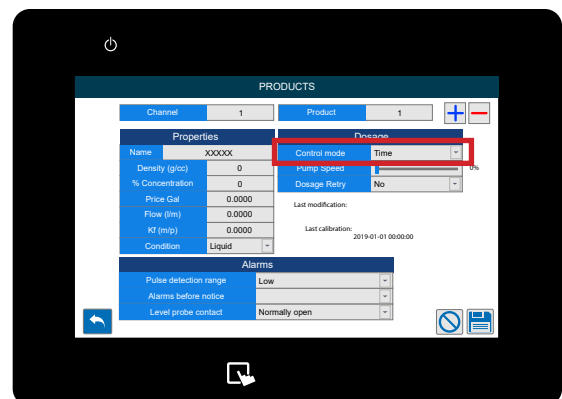

SETTING UP A PRODUCT ON YOUR UNIT

STEP 13

Below you can now adjust the **Pump Speed** for this chemical.

We recommend a speed of;

- 80% - 100% for high volume delivery
- 30% - 80% for low volume delivery
- **DO NOT** use below 30% speed for delivery

**Please note - If you change the pump speed a calibration MUST be run. This can be found here: Running a Calibration (P35)*

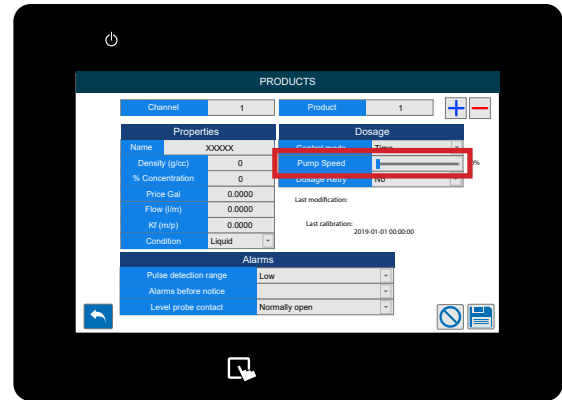

STEP 14

The final setting in the dosage column allows you to enable or disable the **Dosage Retry**.

This will enable the system to retry dosing the chemical if the correct number of pulses are not met in the expected delivery time.

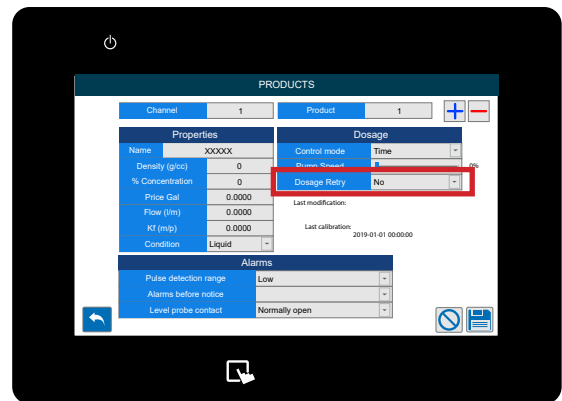

STEP 15

At the bottom of the screen you can see the **Alarms** settings. The first box allows you to setup the **Pulse Detection Range**. You can select between;

- Low (30%)
- Medium (50%)
- High (70%)
- Maximum (100%)

This is the additional time that can be added for the flow meter to detect the correct volume of chemical. A more detailed explanation is found here: [Pulse Detection Range \(P10\)](#)

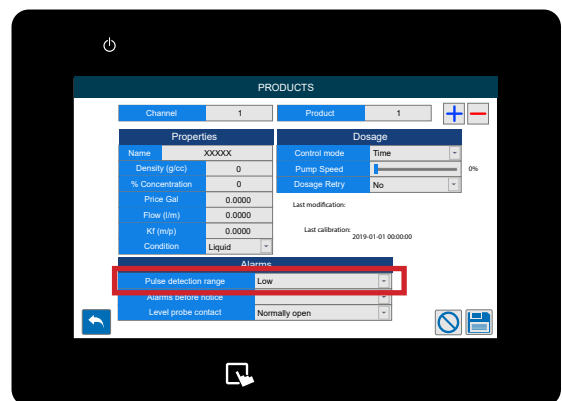

STEP 17

Below this you can set the number of retries before an alarm is raised.

The feature is only available with a flow meter installed. This stops consecutive audio alarms from sounding on the unit to reduce noise pollution in the laundry.

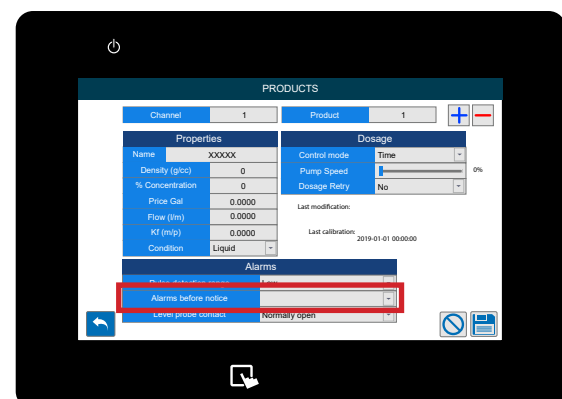

SETTING UP A PRODUCT ON YOUR UNIT

STEP 18

Finally, you can adjust the **Level Probe Contact** to;

- Normally Open
- Normally Closed

Please note - The standard Brightwell products are Normally Closed

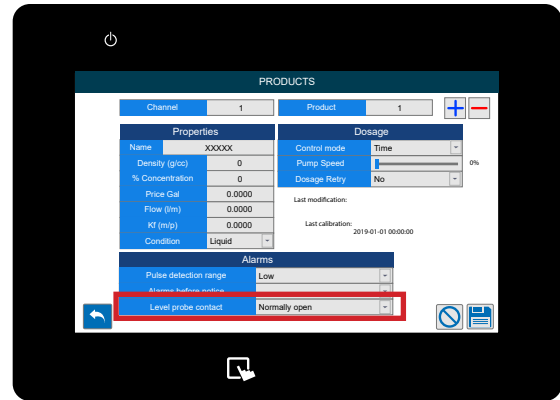

STEP 19

The icons at the bottom of the screen allow you to;

- Go back
- Delete a product (- top right)
- Clear the changes made
- Save the settings

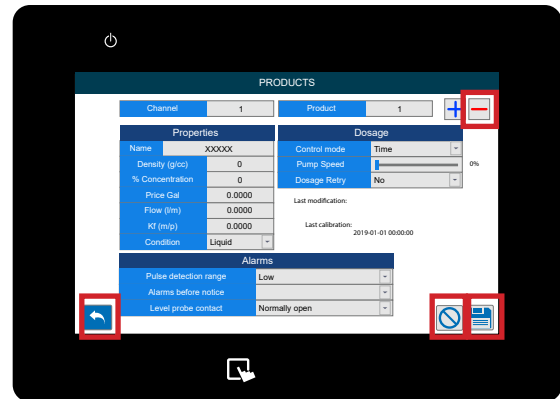

SETTING UP A WASHER ON YOUR UNIT

STEP 1

Once you have logged into your Multiplex system you can setup and edit the Washers via the Washer Extractors menu. To locate this tap the left hand side of the screen to show the **Configuration Menu** icon.

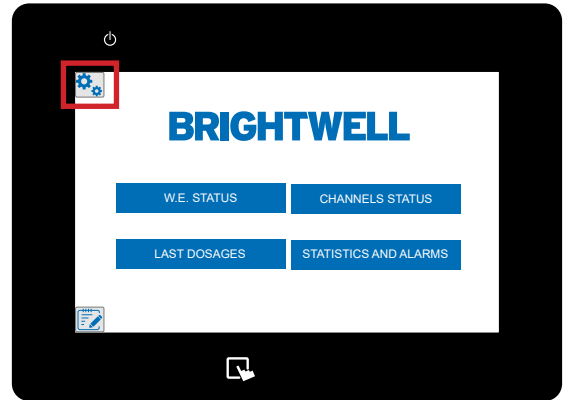

STEP 2

Once this menu has expanded press the **Washer Extractors** button located at the bottom.



STEP 3

The first section allows you to set the custom name for the washer.

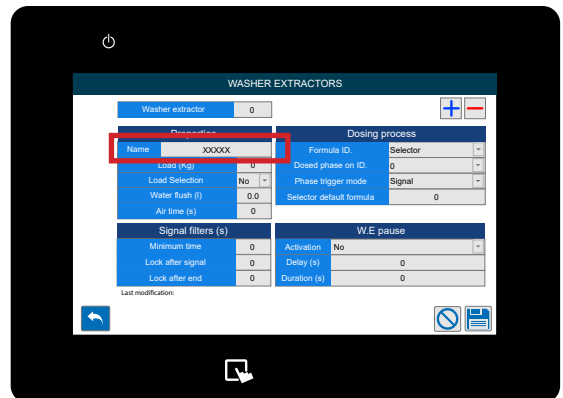

STEP 4

Next, you can set the **Total Load in Kg** for the Washer Extractor.

This field is essential in calculating the total volume to be dosed to the load.

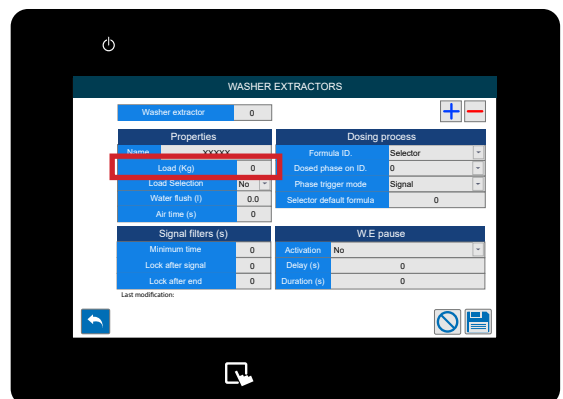

SETTING UP A WASHER ON YOUR UNIT

STEP 5

You can now enable or disable the **Load Selection** for this washer.

This setting requires a formula select, so please contact Brightwell to discuss this setting and equipment if required.

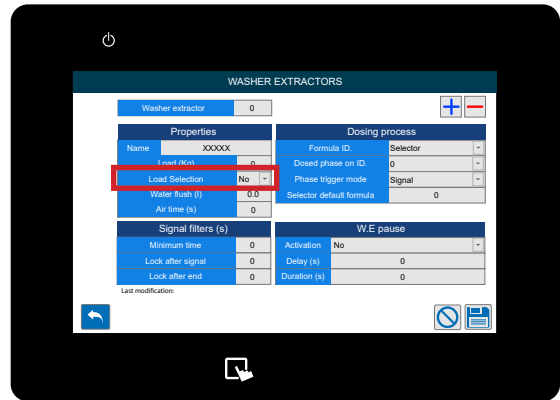

STEP 6

The next box allows you to set the **Water Flush (L)** quantity required.

Alternatively, if you are using air flush you can use the **Air Time (S)** box below.

This value needs to be precise for correct delivery of chemical. Please run a visual check of the water required to completely inject the chemical into the machine, as this varies based on distance from the distributor.

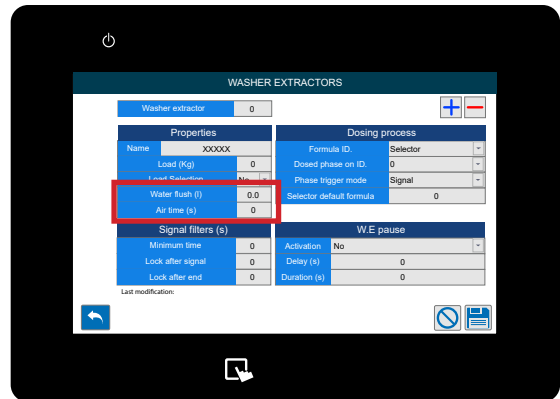

STEP 7

In the Dosing Process column you can first set the **Formula ID** section. This can be;

- Selector
- Time of signal 8
- Time of signal 1+8
- Binary
- Free

Please refer to the next section for a more detailed explanation.

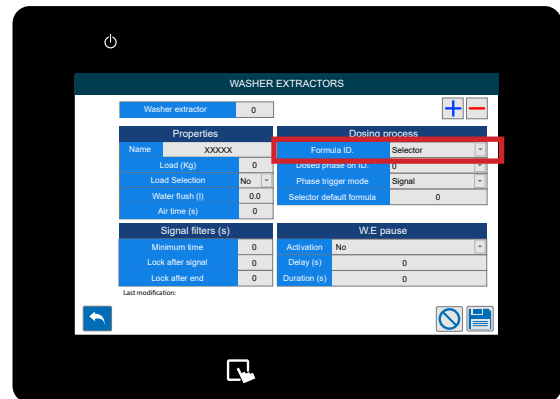

SETTING UP A WASHER ON YOUR UNIT

SIGNAL TIME 8

This selects the program based on 5 second intervals of the Signal 8 going high. This settings is advised for units with a lower number of formulas (1-20). Please refer to the table below for timings.

Formula	Signal 8 Time on	Formula	Signal 8 Time on	Formula	Signal 8 Time on	Formula	Signal 8 Time on
1	5 s	5	25 s	9	45 s	13	65 s
2	10 s	6	30 s	10	50 s	14	70 s
3	15 s	7	35 s	11	55 s	15	75 s
4	20 s	8	40 s	12	60 s	16...	80 s...

SIGNAL TIME 1+8

This selects the program based on the duration of signals 1 and 8 going high simultaneously. This setting is advised for units that have a larger volume of formulas to select (20+) The below table explains the timing and selection details.

Formula	Signal 1 Time on	Signal 8 Time on	Formula	Signal 1 Time on	Signal 8 Time on	Formula	Signal 1 Time on	Signal 8 Time on	Formula	Signal 1 Time on	Signal 8 Time on
1	5 s	5 s	11	10 s	5 s	21	15 s	5 s	31	20 s	5 s
2	5 s	10 s	12	10 s	10 s	22	15 s	10 s	32	20 s	10 s
3	5 s	15 s	13	10 s	15 s	23	15 s	15 s	33	20 s	15 s
4	5 s	20 s	14	10 s	20 s	24	15 s	20 s	34	20 s	20 s
5	5 s	25 s	15	10 s	25 s	25	15 s	25 s	35	20 s	25 s
6	5 s	30 s	16	10 s	30 s	26	15 s	30 s	36	20 s	30 s
7	5 s	35 s	17	10 s	35 s	27	15 s	35 s	37	20 s	35 s
8	5 s	40 s	18	10 s	40 s	28	15 s	40 s	38	20 s	40 s
9	5 s	45 s	19	10 s	45 s	29	15 s	45 s	39	20 s	45 s
10	5 s	50 s	20	10 s	50 s	30	15 s	50 s	40	20 s	50 s

SETTING UP A WASHER ON YOUR UNIT

BINARY

For this mode the unit will select a program based on the below signal combinations.

Formula	8	7	6	5	4	3	2	1
1								
2								
3								
4								
5								
6								
7								
8								
9								
10								
11								
12								
13								
14								
15								
16								

Formula	8	7	6	5	4	3	2	1
17								
18								
19								
20								
21								
22								
23								
24								
25								
26								
27								
28								
29								
30								
31								
32								

Formula	8	7	6	5	4	3	2	1
1								
2								
3								
4								
5								
6								
7								
8								
9								
10								
11								
12								
13								
14								
15								
16								

FREE MODE

Free mode allows the users to build a custom list of formula selection based on incoming signals. These are **ONLY** defined via the web portal or web server, they cannot be defined on the On Screen setup.

SETTING UP A WASHER ON YOUR UNIT

STEP 8

After this you can select the **Dosage Phase ID** number using the drop down here.

This allows you to customise what state the machine will enter on receiving the first signal.

If you set this to Phase 0, the unit will not begin dosing until a signal is received from the washer.

If you set this to Phase 1 the unit will immediately begin to dose after the auto formula select signal is confirmed.

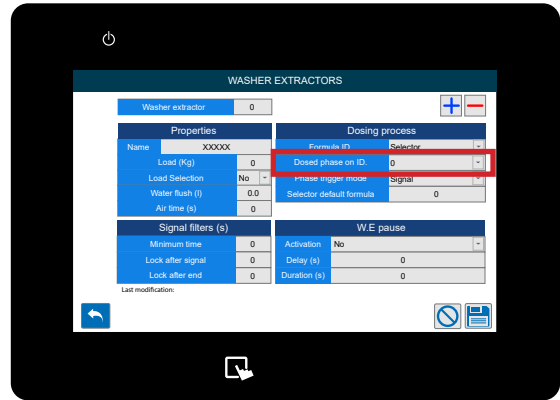

STEP 9

You can now choose between how the phase of dosification is activated, **Signal** or **Sequential**.

Signal mode defines that the machine itself will send a signal to identify what phase it is entering.

Sequential mode sets it so that it will move sequentially through the phases one by one in a logical order.

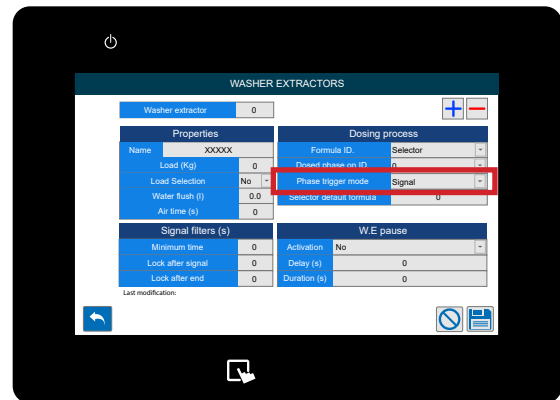

STEP 10

If you have **Selector** chosen you will also have the option to set the **Selector Default Formula**. Which will default back to after a successful cycle.

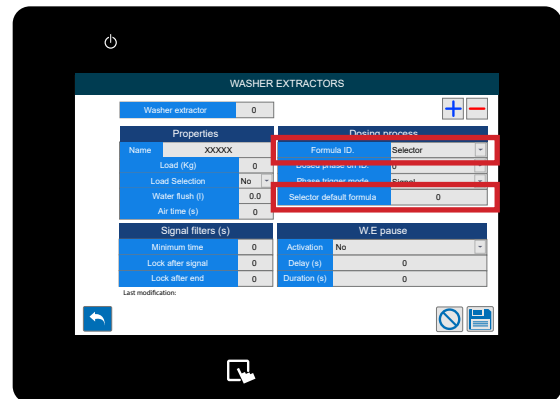

STEP 11

In the **Signal Filters** column the first box allows you to adjust the **Minimum Time** for an accepted signal. This stops ghost signals from triggering the machine.

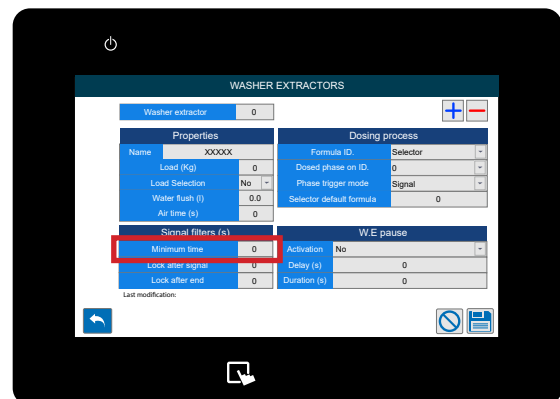

SETTING UP A WASHER ON YOUR UNIT

STEP 12

You can then adjust the time that the device would block reception of signals, after having received a valid signal.

With this option we prevent possible "bounces" of a signal from being mistaken for input signals.

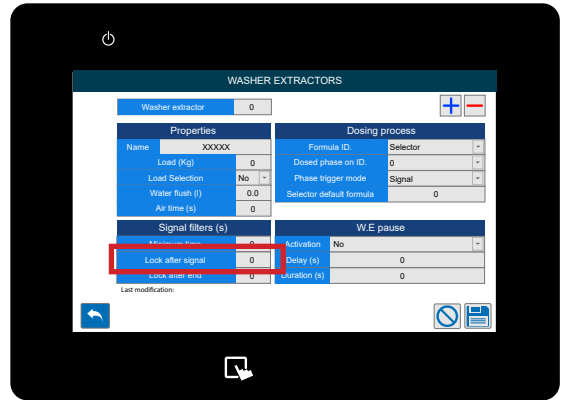

STEP 13

The final box in the **Signal Filters** column allows you to adjust the **Lock time** for the equipment to allow new signals, once the **RESET** has been completed.

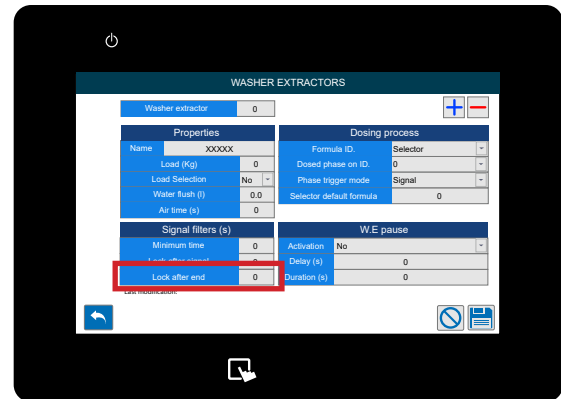

STEP 14

The last column is the **W.E Pause (Washer Extractor Pause)** section.

The first box allows you to adjust the Activation between;

- No (Deactivated)
- While in queue
- While in queue and dosage

The washer pause functionality allows for 'queuing' of machines when they request chemical delivery while the unit is busy.

When a machine is 'waiting' its timer is paused so that the wash can complete a full cycle correctly. The above options allow you to adjust when the 'pause timer' begins again.

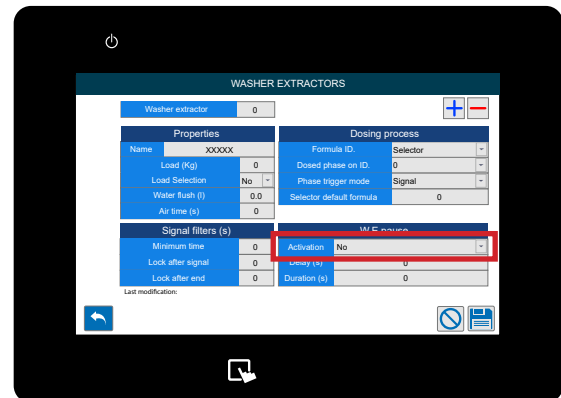

SETTING UP A WASHER ON YOUR UNIT

STEP 15

After this you can setup the pause function **Delay Time**.

This will only start the Machine Pause function after the set time has been completed. This is beneficial for older machines.

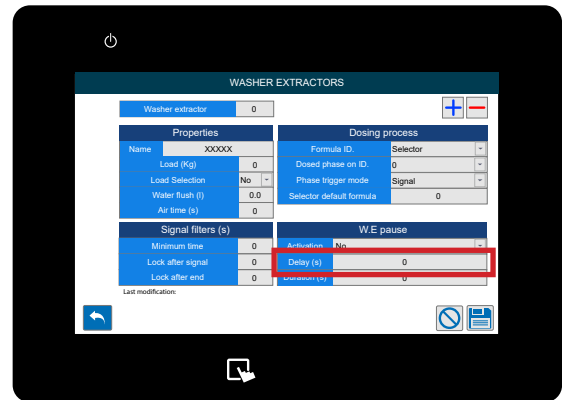

STEP 16

Finally, you can set the pause function **Duration**.

This will set a limit for the time the Machine Pause can remain active. This stops the machines from being locked if there is equipment failure.

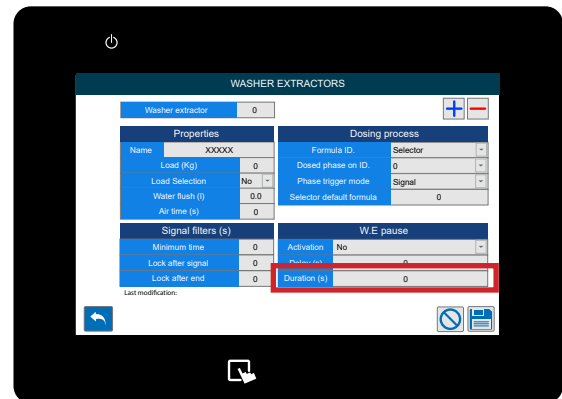

STEP 17

The icons at the bottom of the screen allow you to;

- Go back
- Clear the changes made
- Save the settings

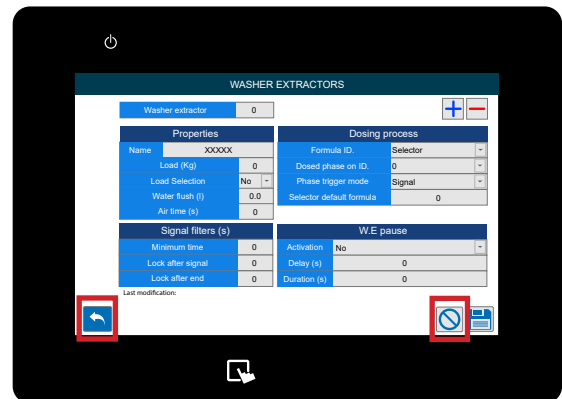

SETTING UP A FORMULA ON YOUR UNIT

STEP 1

Once you have logged into your Multiplex system you can setup and edit the Formulas via the Formulas menu. To locate this tap the left hand side of the screen to show the **Formulas Menu** icon.

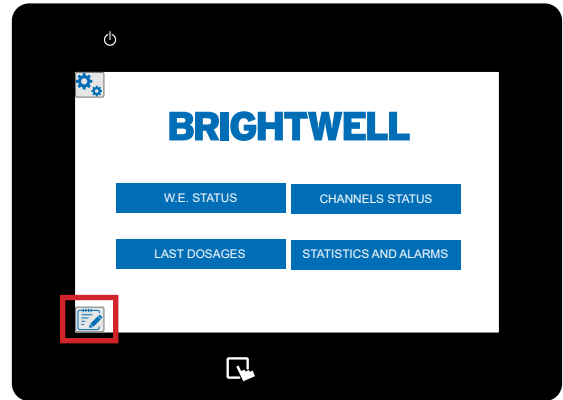

STEP 2

Once this menu has expanded press the **Edit Formulas** button located at the top.



STEP 3

The first box allows you to set the **Formula number**.

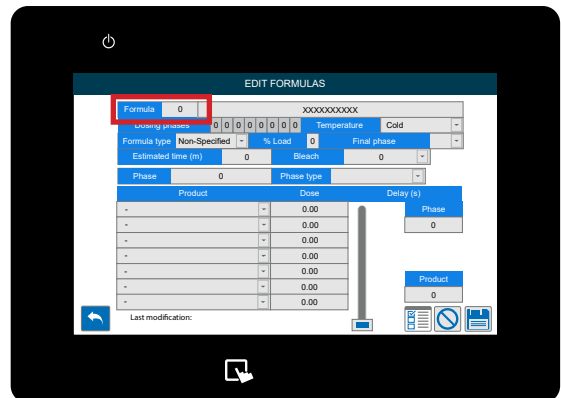

STEP 4

The next box allows you to set the **Formula Name**.

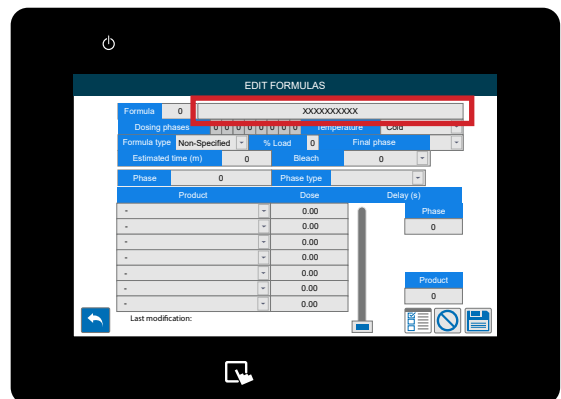

SETTING UP A FORMULA ON YOUR UNIT

STEP 5

Press the **Signals** icon in the bottom right to see the **Free Mode Signals** identifier.

Free mode allows the users to build a custom list of formula selection based on incoming signals. These are **ONLY** defined via the web portal or web server, they cannot be defined on the On Screen setup.

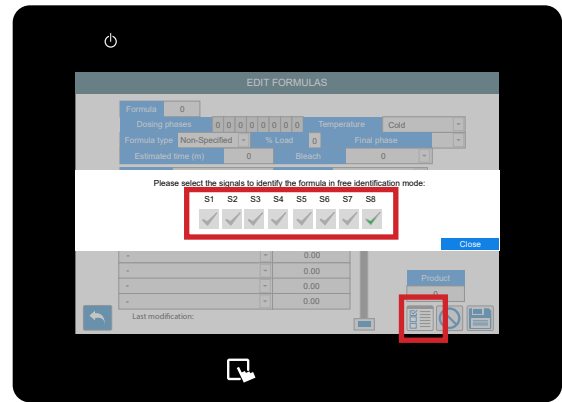

STEP 6

You can now set the desired temperature for the formula;

- Cold
- Warm
- Hot
- High Temperature

This data is informative. It will be useful to obtain more complete statistics.

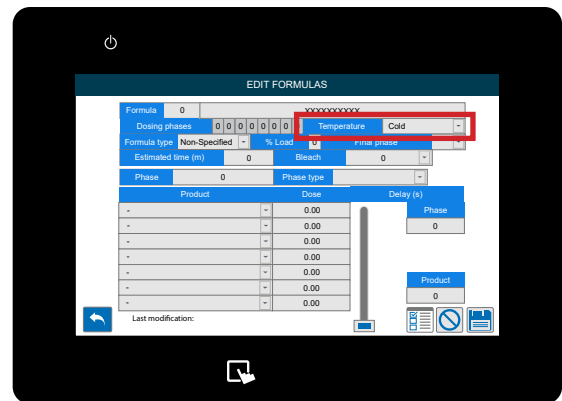

STEP 7

You can now select the type of formula you are creating;

- Delicate
- Normal
- Heavy Soil
- Re-Process
- Desize
- Rinse/Spinning
- Recovery
- Other

This data is informative. It will be useful to obtain more complete statistics.

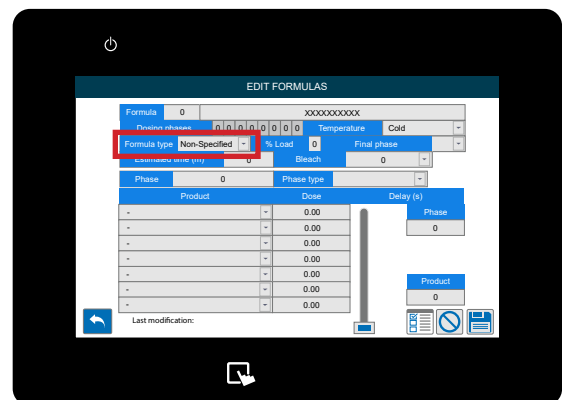

STEP 8

The next box allows you to set the **Load Percentage**.

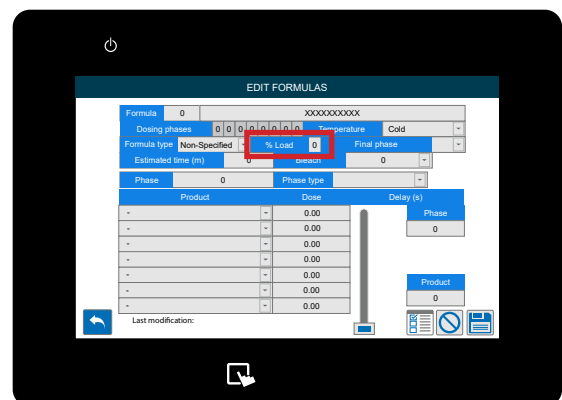

SETTING UP A FORMULA ON YOUR UNIT

STEP 9

Use the drop down here to select the Final Phase for the formula.

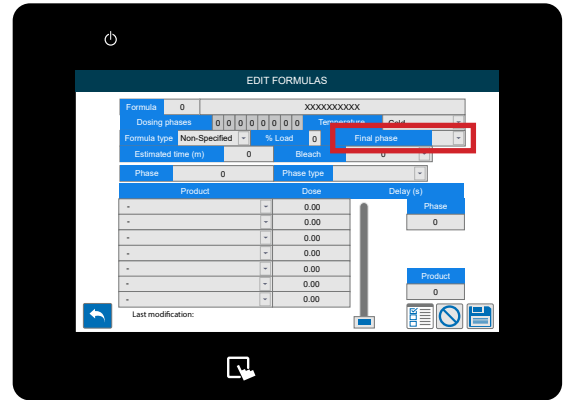

STEP 10

Setup the Estimated Time for run time of the Formula.

This data is informative. It will be useful to obtain more complete statistics.

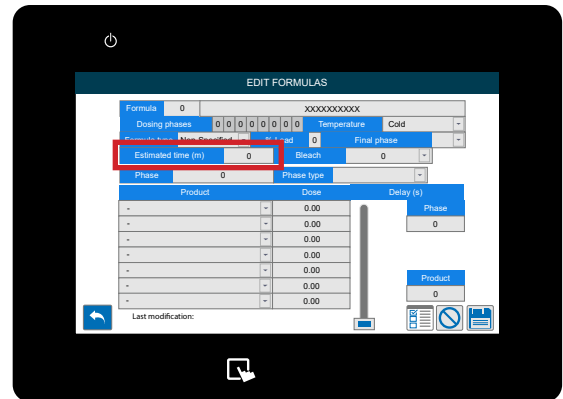

STEP 11

If you have bleach for this Formula, you can use the drop down here to select;

- Non Specified
- No bleach
- Yes (No chlorine)
- Yes (With chlorine)

This information is informative. It will be useful to get more detailed information about possible problems via the integrated "Help" function.

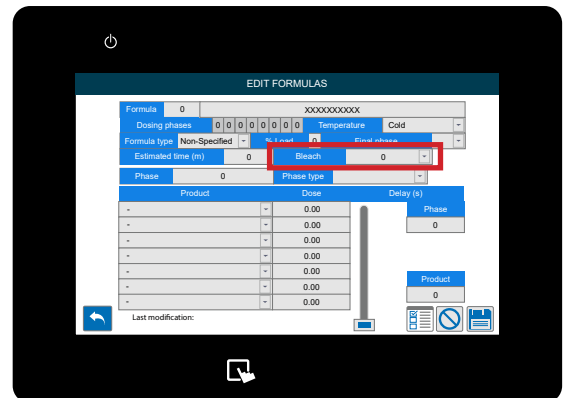

STEP 12

The next box allows you to select the Phase number, this will allow you to set the Phase Type;

- Delicate
- Normal
- Heavy Soil
- Re-Process
- Desize
- Rinse/Spinning
- Recovery
- Other

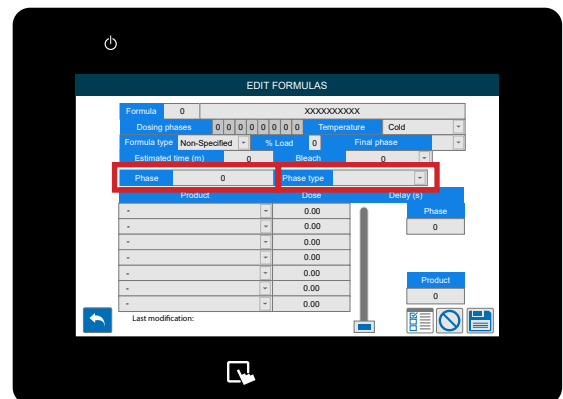

SETTING UP A FORMULA ON YOUR UNIT

STEP 13

Once you have set up the Phase Type settings you can select the Chemicals you want to use and the amount you want to dose on this formula.

If you do not have any Products setup please see the previous section "Setting up a product on your unit (P12)"

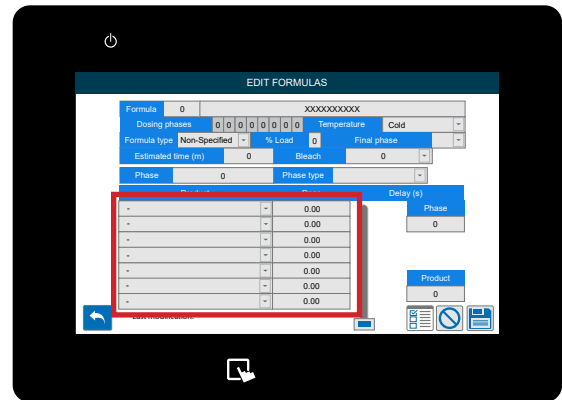

STEP 14

The icons at the bottom allow you to;

- Go back
- Create a new formula
- Clear the changes that were made
- Save the settings

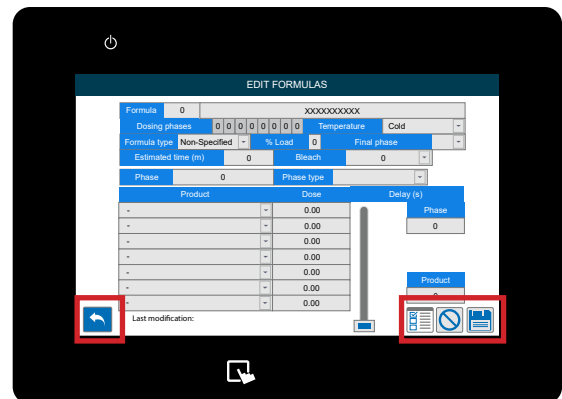

COPYING AN EXISTING FORMULA

STEP 1

Once you have logged into your Multiplex system you can copy an existing Formula via the Formulas menu. To locate this tap the left hand side of the screen to show the **Formulas Menu** icon.

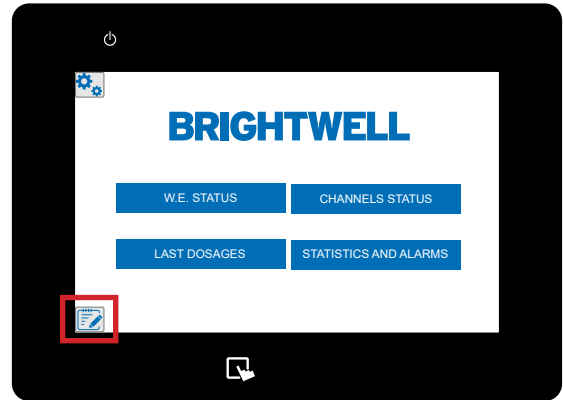

STEP 2

Once this menu has expanded press the **Copy Formulas** button located in the middle.



STEP 3

Once the **Copy Formula** menu has opened press the **Source Formula** box to select the one you want to copy.

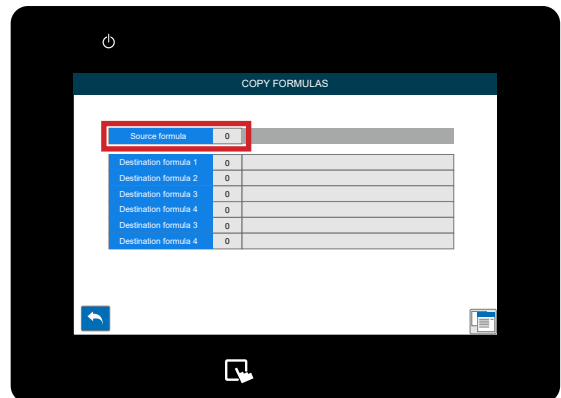

STEP 4

Select the formulas you want to copy the original program settings to using the boxes provided.

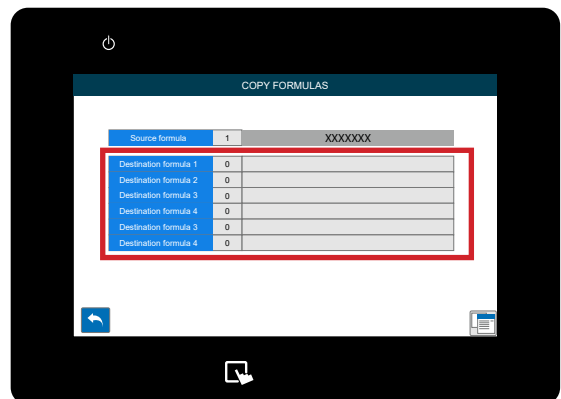

COPYING AN EXISTING FORMULA

STEP 5

Once you have selected all the formulas you want to copy to press the **Copy icon** in the bottom right to complete.

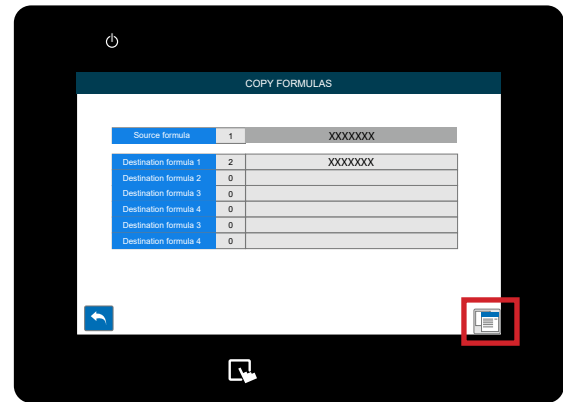

WASHER EXTRACTOR STATUS

STEP 1

Once you have logged into your Multiplex system you can access the **Washer Extractor Status** screen using the icon on the main screen.

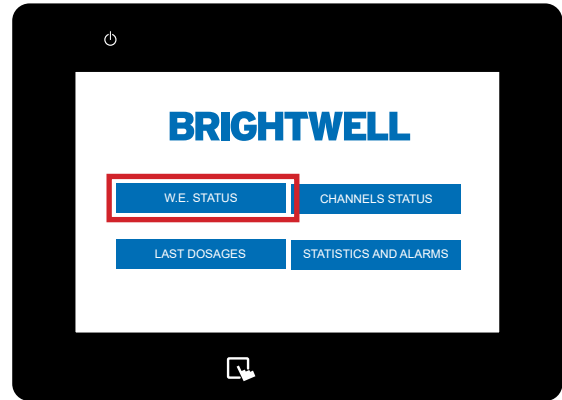

STEP 2

You will now be shown the overview screen displaying all current **Washers** connected to the unit.

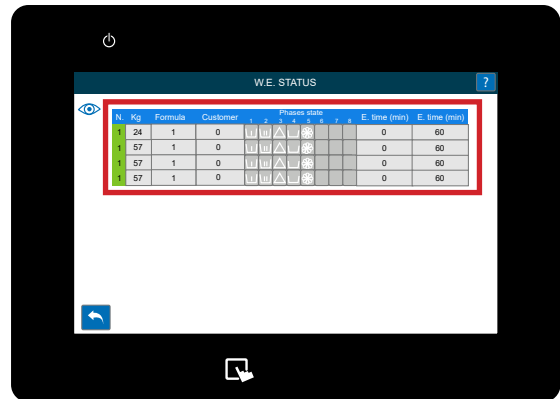

STEP 3

Pressing the **question mark** in the top right of the screen will display the colour coding for the washer status.

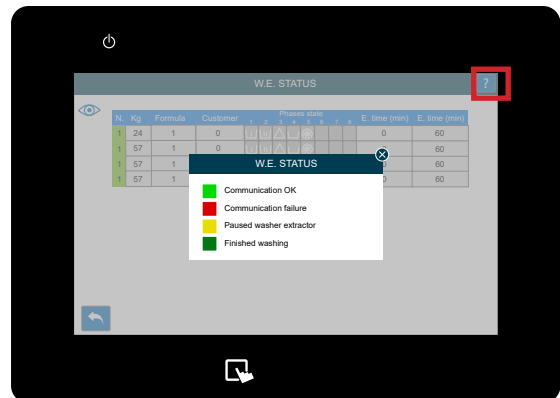

STEP 4

Press on a specific washer in the list will open the more detailed view.

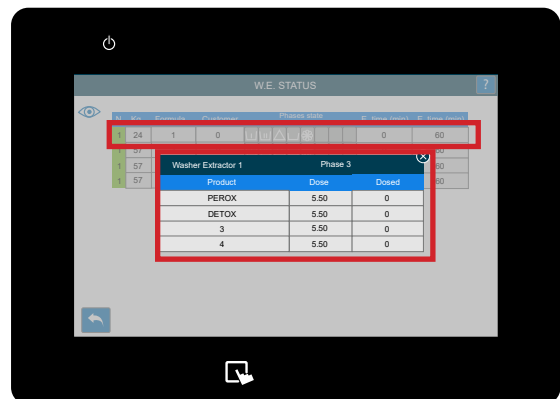

WASHER EXTRACTOR STATUS

STEP 5

Pressing the eye icon in the top left will change the visual style of the washer view.

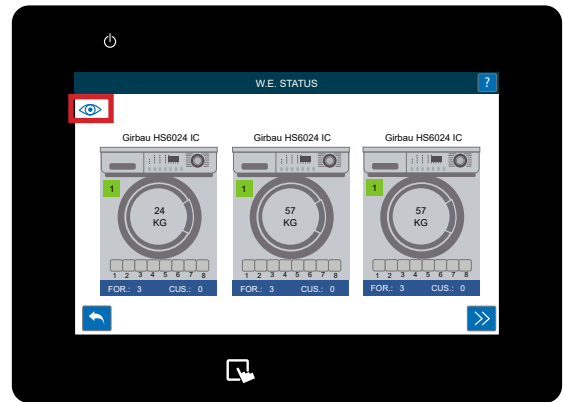

STEP 6

If you press one of the washers in the above view it will open up the in depth data screen for it. Showing more details about completed cycles and status information. You can refresh the data with the icon in the bottom right, alternatively you can move to the next washer using the arrow icon.

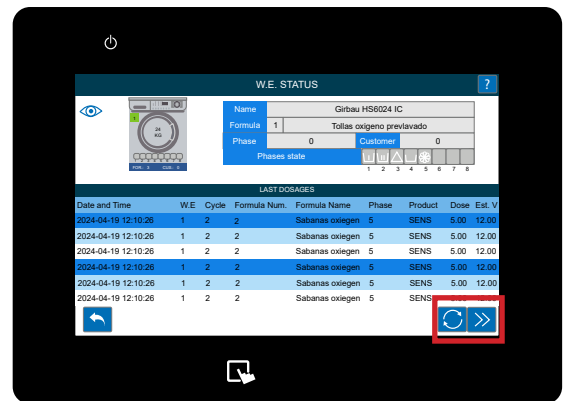

CHANNEL STATUS

STEP 1

Once you have logged into your Multiplex system you can access the **Channel Status** screen using the icon on the main screen.

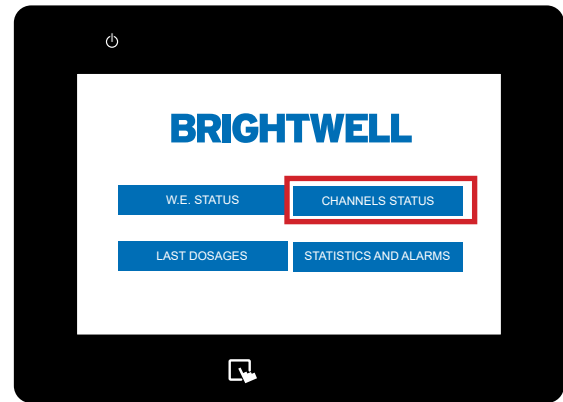

STEP 2

This will open up a current configuration of the channel. You can see all connected outputs to products and washers and outputs via this screen. If you use the Next arrow in the bottom right you can move between the other wiring diagrams for your setup.

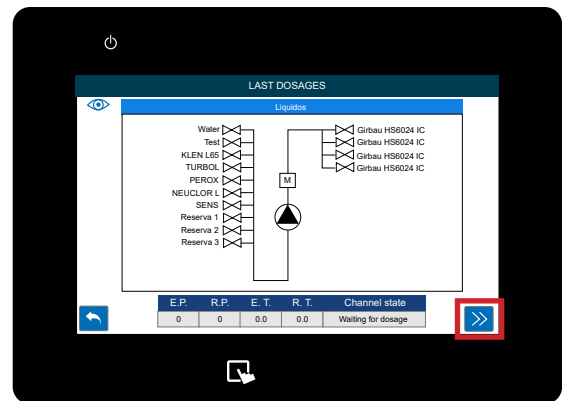

LATEST DOSAGES

STEP 1

Once you have logged into your Multiplex system you can access the **Latest Dosages** screen using the icon on the main screen.

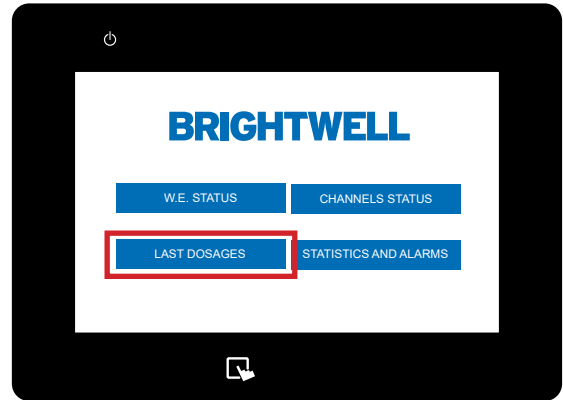

STEP 2

You will now be shown the overview screen displaying all the latest dosage information for a quick overview of history.

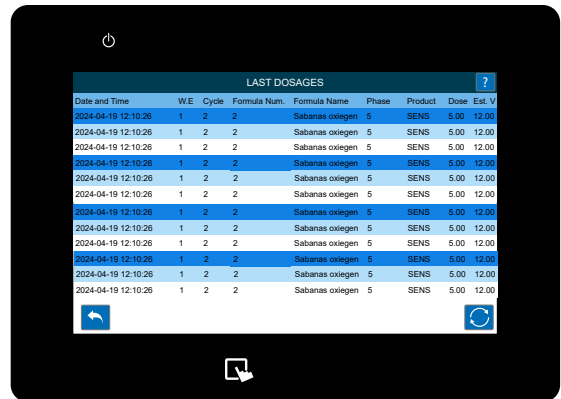

PRODUCTION STATISTICS AND ALARMS

STEP 1

Once you have logged into your Multiplex system you can access the **Statics and Alarms** screen using the icon on the main screen.

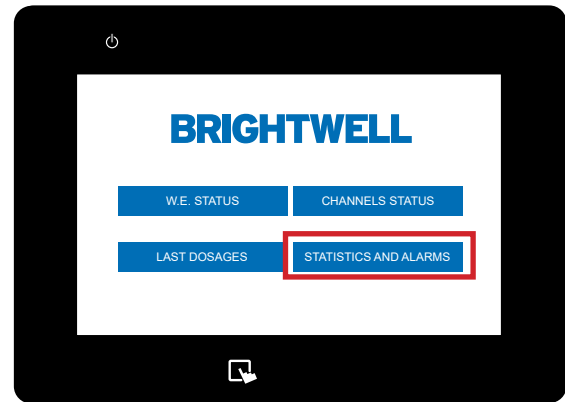

STEP 2

You can now select the **date range** you wish to run the report between.

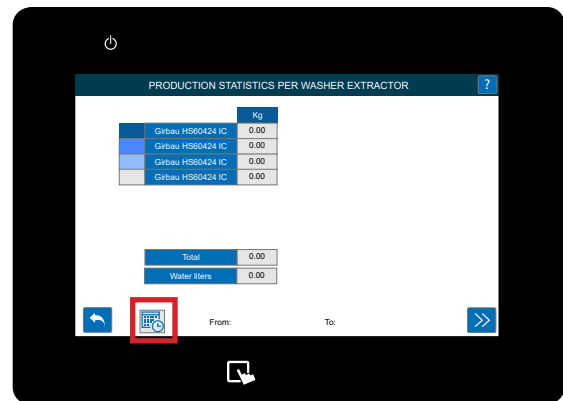

STEP 3

Use the calendar pop-up provided to select the correct dates for your data range. Once you have the dates set press the **Refresh** icon to generate the graph.

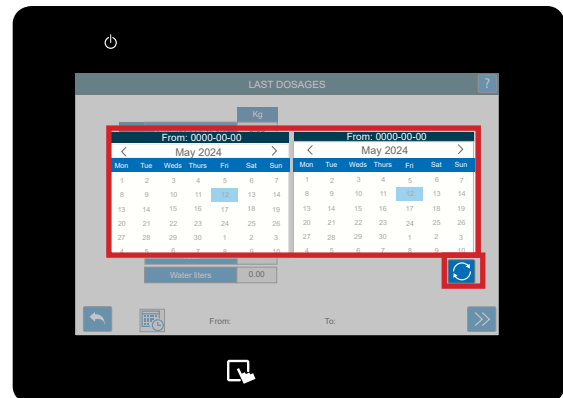

STEP 4

A pie chart will be generated displaying the current data of your unit. Using the Next arrow will allow you to switch between all the data for your unit between your chosen dates.

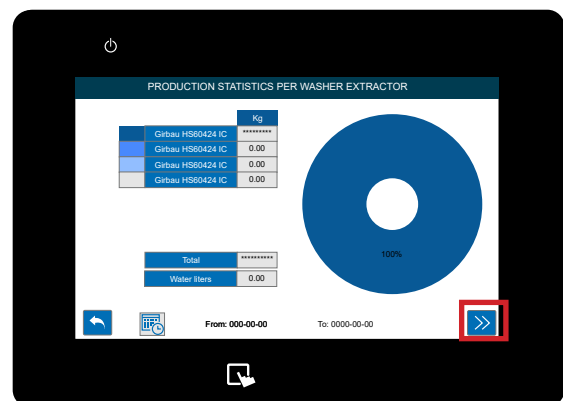

RUNNING A CALIBRATION ON YOUR UNIT

STEP 1

Once you have logged into your Multiplex system you can calibrate the unit by pressing the **Calibrate Icon**. To locate this tap the right hand side of the screen to show the **Calibration** icon.

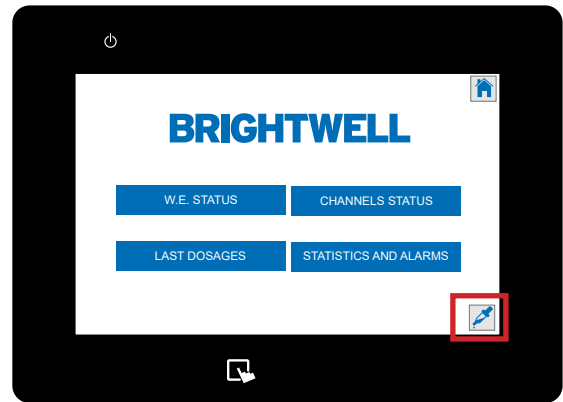

STEP 2

Once this menu has expanded press the **Calibration** button located here.

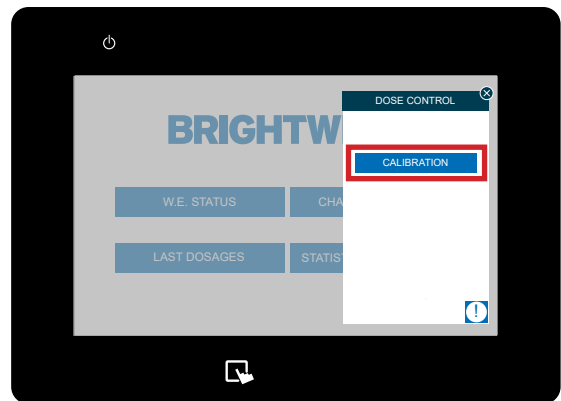

STEP 3

The first box allows you to select the type of calibration you are running you can select;

- Water
- Product

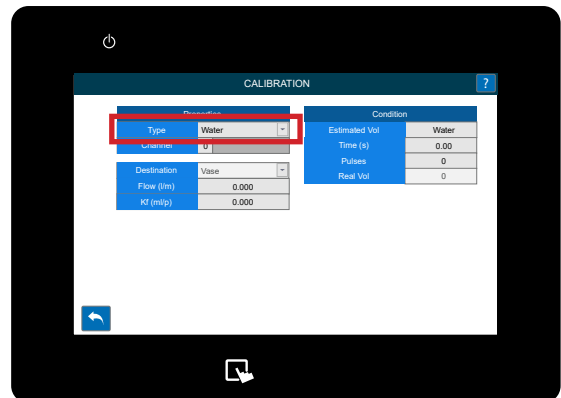

STEP 4

Select the **Channel** you would like to run the calibration on.

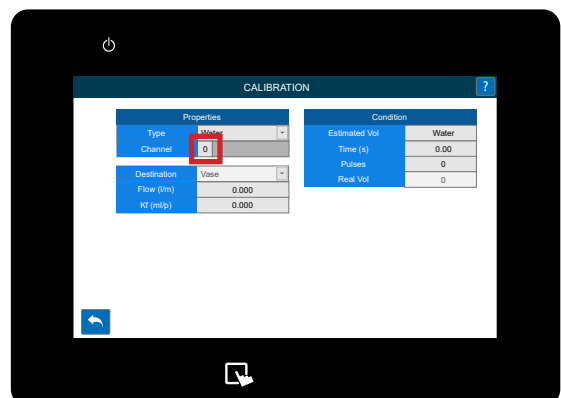

RUNNING A CALIBRATION ON YOUR UNIT

STEP 5

If you selected **Product** you will have access to the Product selection menu.

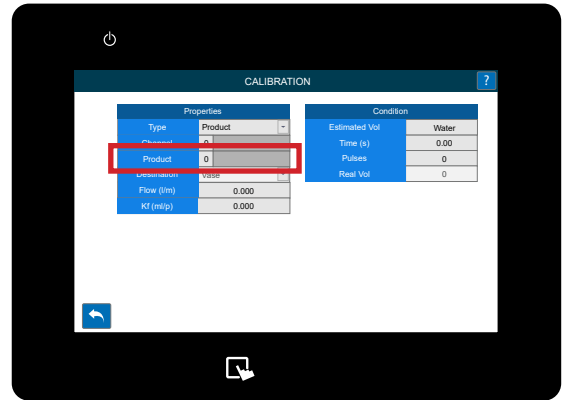

STEP 6

You now need to specify the destination for the liquid during the calibration. This can be;

- Vase
- Another outlet from the unit (If you do not have a measuring vase attached and are using a measuring jug or similar device)

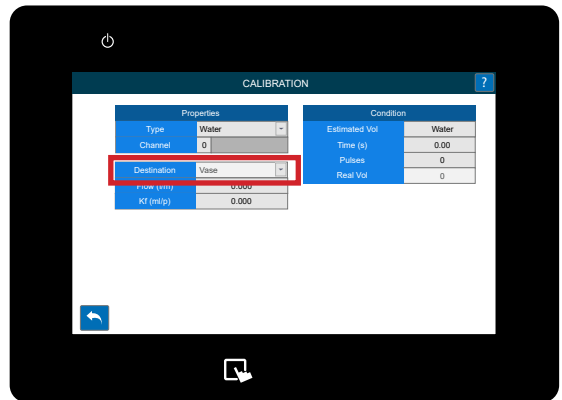

STEP 7

Once you have finished the setup **press and hold** the **Calibration** button on the unit and it will begin to pump the product. Please confirm you have a vase or container to collect the chemical attached to the outlet.

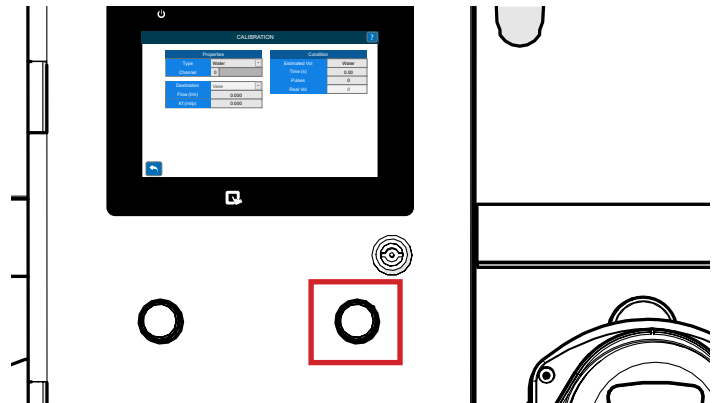

STEP 8

As long as the button is held you will see the **Time** numbers increasing.

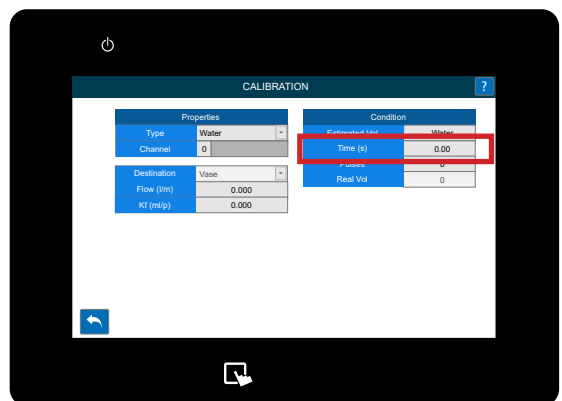

RUNNING A CALIBRATION ON YOUR UNIT

STEP 9

Once you are happy with the volume, release the calibration button and enter the value in the **Real Vol** box seen here.

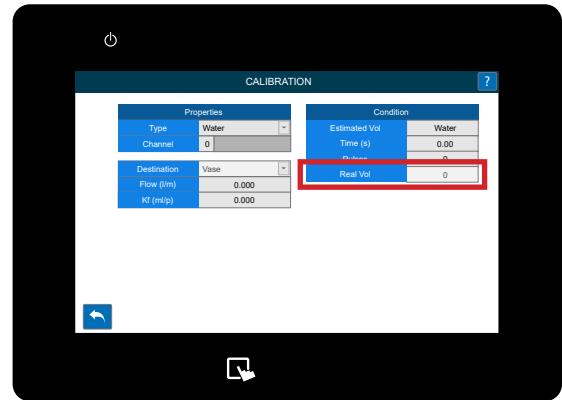

STEP 10

If you have run a calibration on a product you will need to clean the channel. Immediately after the **Real Volume** has been entered the following screen will appear.



STEP 11

Press and hold the **Clean** button that has appeared. The bar will begin to fill up. Hold this until 100% has been reached to confirm that no chemical remains in the channel.

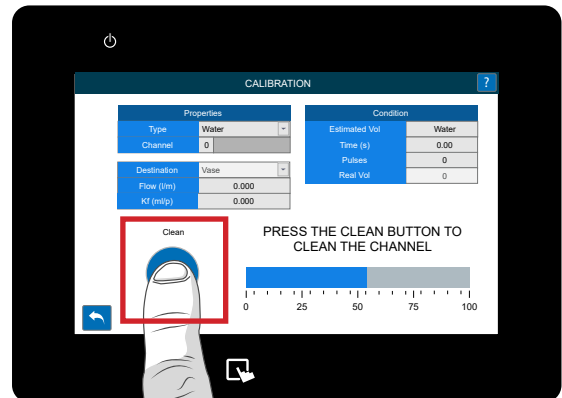

CHANGING THE LANGUAGE ON YOUR UNIT

STEP 1

To change the language on your unit locate the **Administration** icon from the right hand menu.

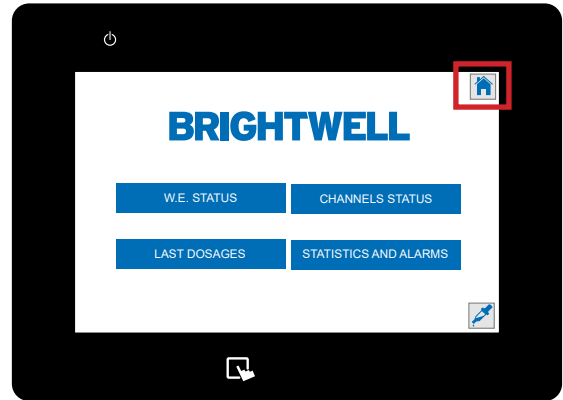

STEP 2

Press the **Language** button at the top.

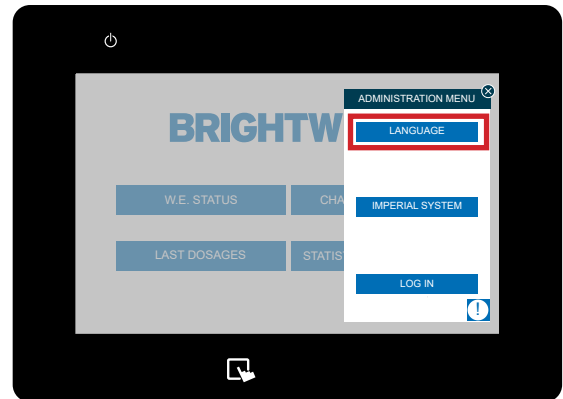

STEP 3

Press the desired flag for your language.

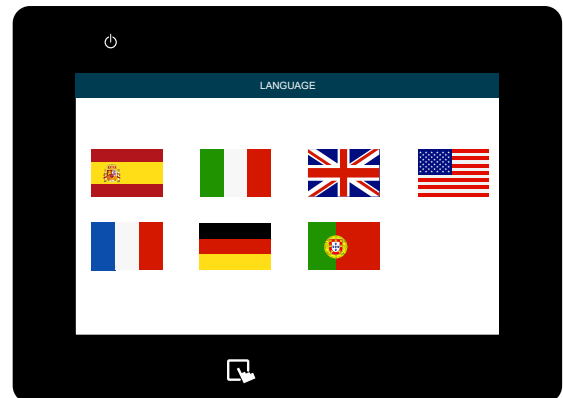

CHANGE THE UNIT OF MEASUREMENTS

STEP 1

Once you have logged into your Multiplex system tap on the **Administration Menu** icon in the top right of the screen.

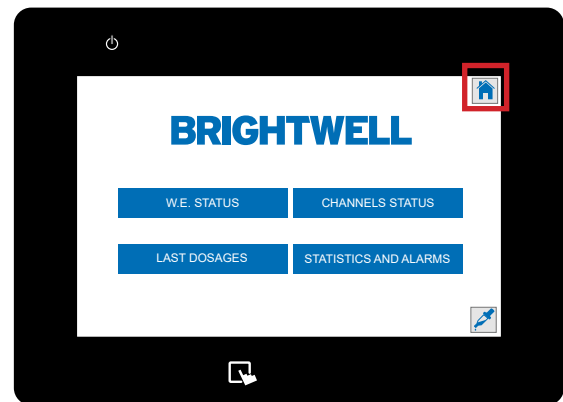

STEP 2

Press and hold the second button for 5 seconds.

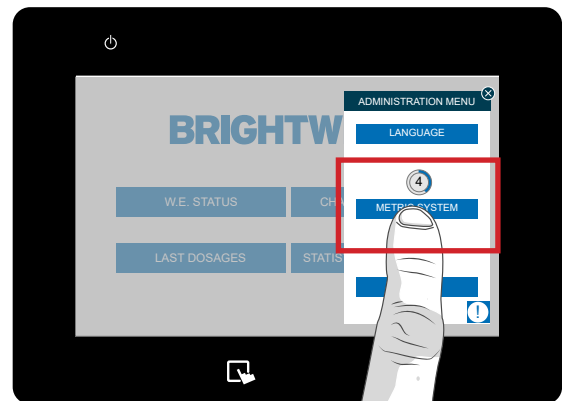

STEP 3

The units of measurement will be changed.



CHANGING DOSAGE VOLUME UNITS

STEP 1

Once you have logged into your Multiplex system you can change the dosage volume measurements. To locate this tap the left hand side of the screen to show the **Formulas Menu** icon.

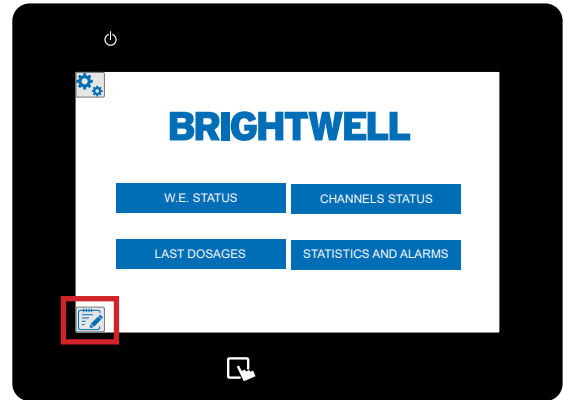

STEP 2

Press and hold the **Dose:** button for 5 seconds.



STEP 3

The dosage measurement will now be changed.

